

CS

s instalační
krabicí do zdi
- index Z

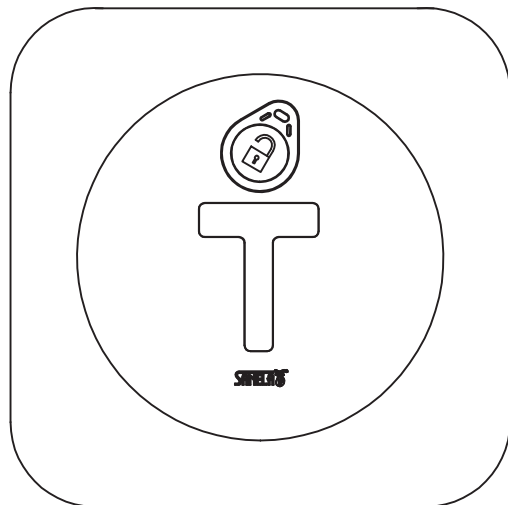

na zed'

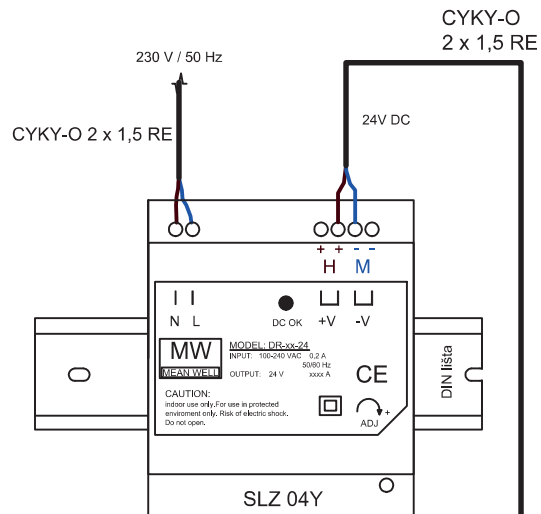
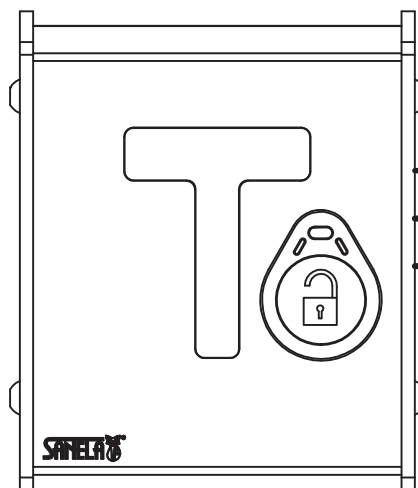

Vodiče nechat dlouhé 40 cm
od zdi a před zapojením
odstranit vnější izolaci kabelu
- pro snadnější modelování
kabelů uvnitř zařízení. (viz
stavební přípravenost)

24 V DC

1

TL 1

CYKY-O
2 x 1,5 RE

CYKY-O 2 x 1,5 RE (bez dveřního kontaktu)
nebo
CYKY-O 4 x 1,5 RE (s dveřním kontaktem)

Délka vodičů od RFID jednotky k
zámku max. 50 metrů.

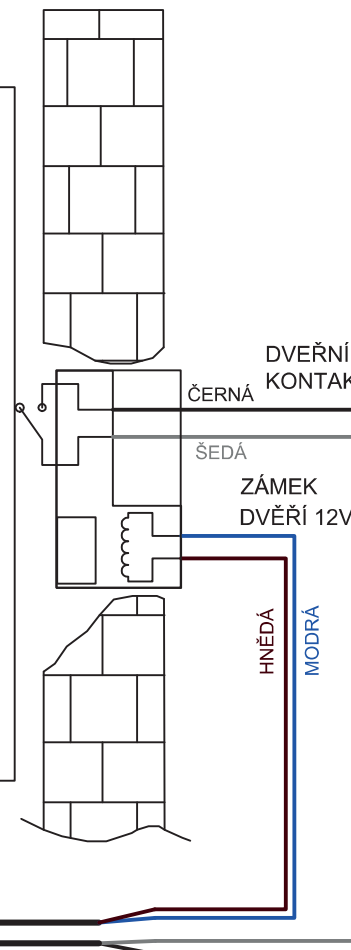
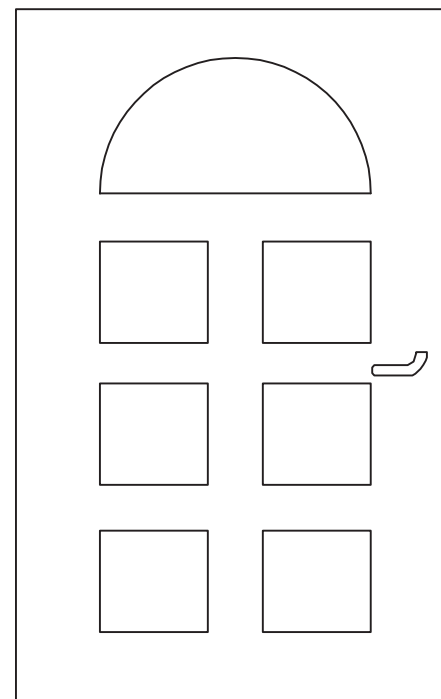

INSTALACE:

Montáž výrobku smí provádět pouze osoba způsobilá s
příslušným oprávněním dle návodu a předpisů
(zde podle vyhl. č. 50/78 Sb.).

EN

with installation box into the wall
- Index Z

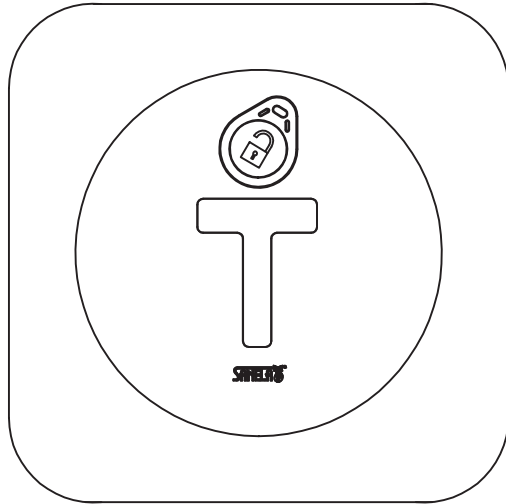

Wall installation

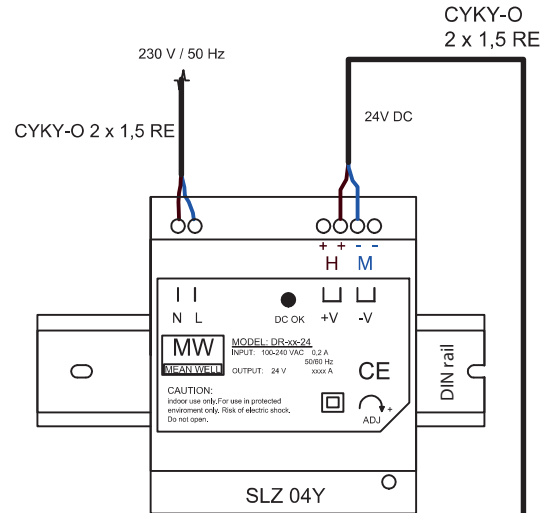
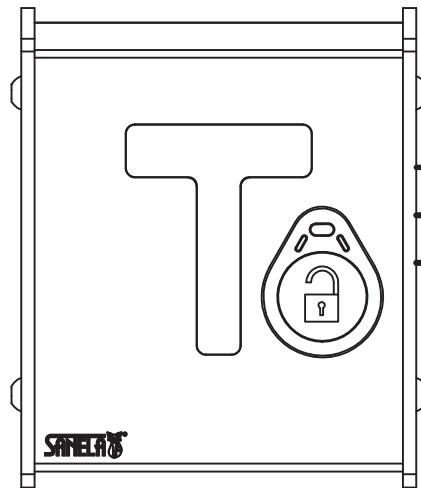

Wires in the box must be min. 40 cm long (from the wall). Before installation, remove the outer cable insulation for easier handling in the box. (see mounting diagram)

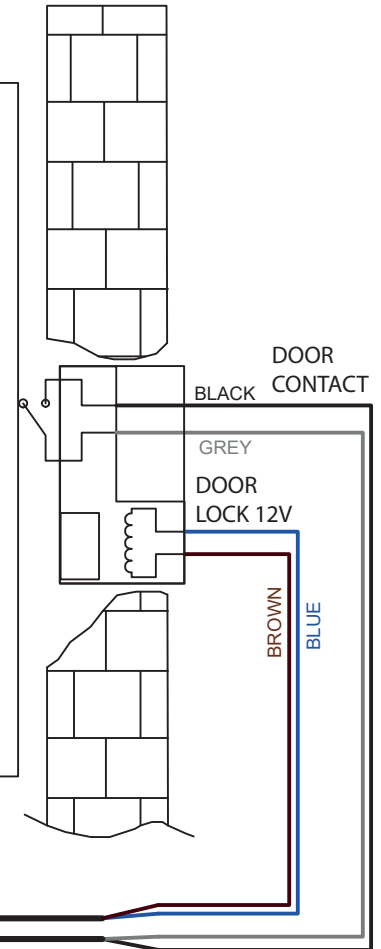
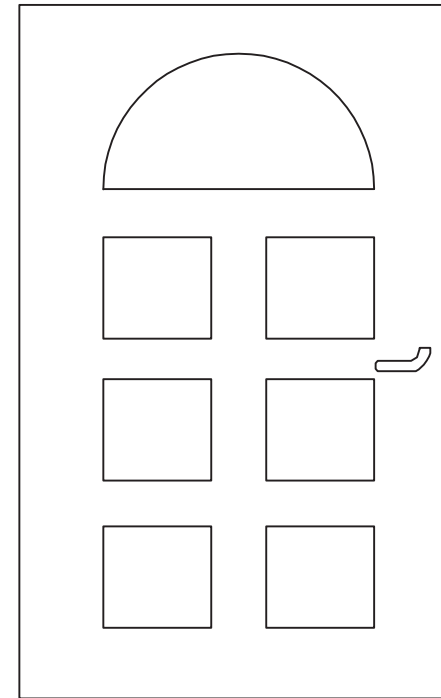

The length of the cables from the central unit to the door lock can be a maximum of 50 meters.

CYKY-O 2 x 1,5 RE (version without door contact)
or
CYKY-O 4 x 1,5 RE (version with door contact)

INSTALLATION:

Installation of the product may only be carried out by qualified persons with the appropriate authorization in accordance with the instructions and regulations at the installation site!

DE mit Installationsbox
in die Wand
- Index Z

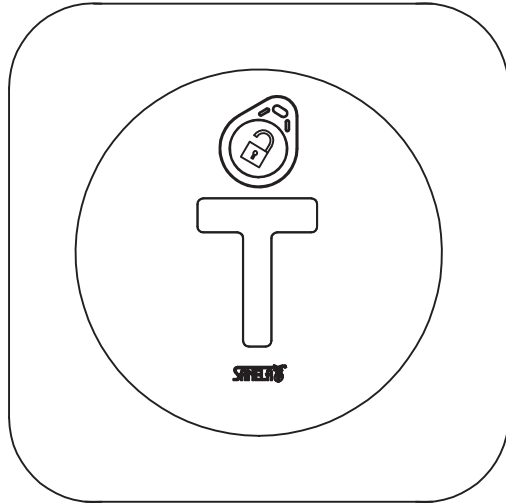

Wandmontage

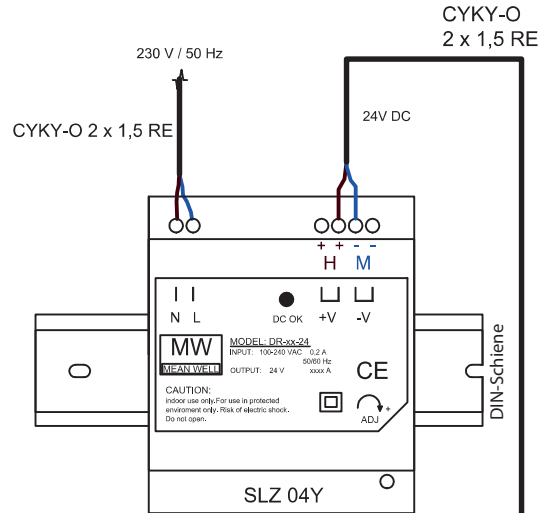
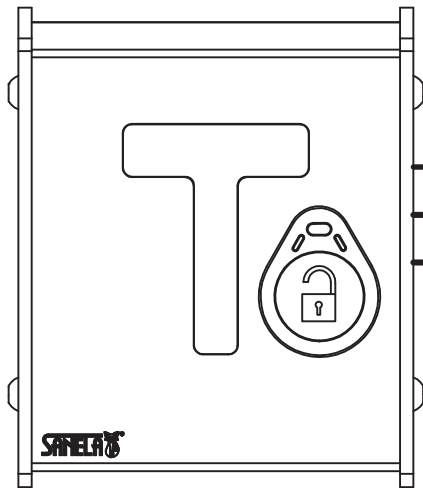

Drähte im Schrank müssen min. 40 cm lang (von der Wand). Vor der Installation entfernen Sie die äußere Kabelisolierung für eine einfachere Handhabung im Schrank. (siehe Baubereitschaft)

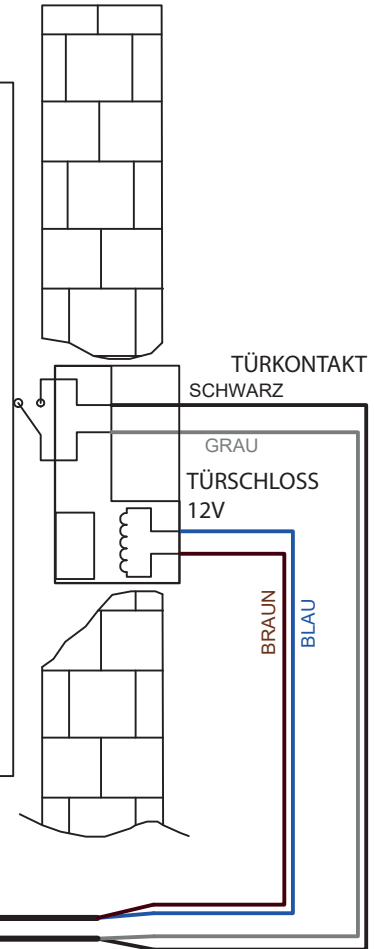
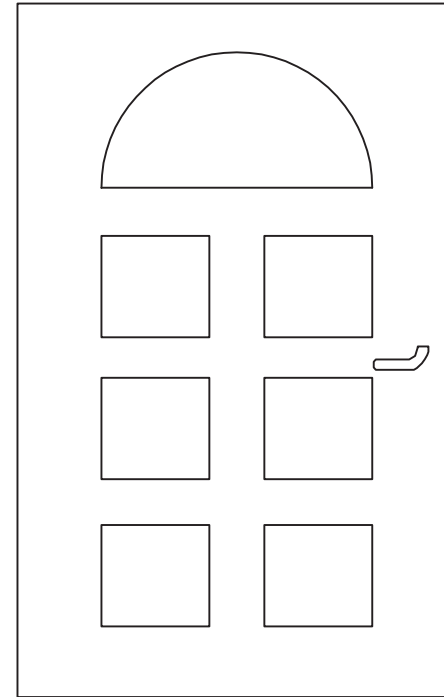

Die Länge der Kabel von der Münzeinheit zur Türschloss kann maximal 50 Meters betragen.

CYKY-O 2 x 1,5 RE (Version ohne Türkontakt)
oder
CYKY-O 4 x 1,5 RE (Version mit Türkontakt)

INSTALLATION:

Installation des Produkts darf nur von qualifizierten Personen mit entsprechender Berechtigung gemäß den Anweisungen und Vorschriften am Aufstellort durchgeföhrt werden